

SPECIFICATIONS FOR T5C SERIES

WHITE LED

Model: 5050

Part No: T5C***82C-R****

Features:

- * Top view white LED
- * Thermally Enhanced Package Design
- * High luminous flux output
- * High current capability
- * Compact Package Size
- * Wide viewing angle
- * Pb-free Reflow Soldering Application
- * The product itself will remain within RoHS compliant version

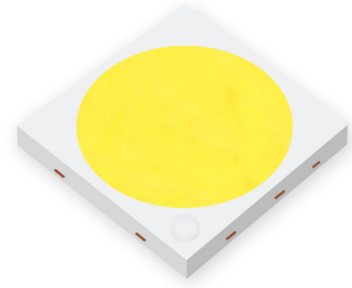

Applications

- * Interior lighting
- * Retrofits (replacement)
- * General lighting
- * Architectural / Decorative lighting

Part Numbering System

T □□ □□ □ □ □ □ - □ □□ □□ □
 X1 X2 X3 X4 X5 X6 X7 X8 X9 X10

Item Number Code	Description	Content
X1	Type code	1S:1010; 1A:1919; 20:2016; 3B:3014; 28:2835 34:3020; 3C:3030; 5C:5050; 7C:7070; 1D:100100; 19: Ceramic 3535; 15: Ceramic 5050; 11: Ceramic 1616.
X2	CCT code	2700K:27; 3000K:30; 4000K:40; 5000K:50; 5700K:57; 6500K:65.
X3	Color Rendering	Ra70:7; Ra80:8; Ra90:9.
X4	No. of serial chip	1-Z.
X5	No. of parallel chip	1-Z.
X6	Component code	A-Z.
X7	Color Code	M:ANSI; F:ERP; R:85℃ ANSI; T:105℃ ANSI; B:Backlighting; Q:Others;
X8	Internal code1	\
X9	Internal code2	\
X10	Spare code	\

Electro Optical Characteristics, IF = 200mA, Tj = 25°C

CCT	Color Rendering	Luminous Flux	
	Min	Typ	Min
2700K	70	635	550
	80	605	550
	90	515	450
3000K	70	665	600
	80	635	550
	90	540	450
4000K	70	700	600
	80	665	600
	90	565	500
5000K	70	700	600
	80	665	600
	90	565	500
5700K	70	700	600
	80	665	600
	90	565	500
6500K	70	700	600
	80	665	600
	90	565	500

* Tolerance of measurements of the Luminous Flux is $\pm 7\%$.

* Ra measurement tolerance is ± 2 .

Absolute Maximum Ratings at Tj=25°C

Item	Symbol	Absolute Maximum Rating	Unit
Forward current	IF	220	mA
Pulse Forward current	IFP	330	mA
Power Dissipation	PD	5940	mW
Reverse Voltage	VR	5	V
Operating Temperature	Topr	-40~+105	°C
Storage Temperature	Tstg	-40~+85	°C
Junction Temperature	Tj	120	°C
Soldering Temperature	Tsld	Reflow Soldering: 230°C or 260°C for 10sec	

* I_{FP} condition with Pulse: Width≤100μs, Duty cycle≤1/10.

* LED's properties might be different from suggested values like above and below tables if operation condition will be exceeded our parameter range. Care is to be taken that power dissipation does not exceed the absolute maximum rating of the product.

* All measurements were made under the standardized environment of Lightning LED.

Electrical/Optical Characteristics at Tj=25°C

Item	Symbol	Min	Typ	Max	Unit	Condition
Forward Voltage	VF	23	25	27	V	IF=200mA
Reverse Current	IR	-	-	10	μA	VR=5V
View Angle	2θ _{1/2}	-	120	-	°	IF=200mA
Thermal resistance	(R _{th j-sp})	-	3	-	°C/W	IF=200mA
Electrostatic Discharge	ESD	1000	-	-	V	HBM

* Tolerance of measurements of the Forward Voltage is ±3%.

* 2θ_{1/2} is the off-axis where the luminous intensity is 1/2 of the peak intensity.

* R_{th j-sp} is the thermal resistance from LED junction to solder point on MCPCB with electrical power.

Bin Structure

Luminous Flux Ranks, IF = 200mA, Tj =25°C

CCT	Color Rendering		Luminous Flux		
	Min	Typ	Code	Min	Max
2700K	70	72	GM	550	600
			GN	600	650
			GP	650	700
	80	82	GM	550	600
			GN	600	650
			GP	650	700
	90	92	GK	450	500
			GL	500	550
			GM	550	600
3000K	70	72	GN	600	650
			GP	650	700
			GQ	700	750
	80	82	GM	550	600
			GN	600	650
			GP	650	700
	90	92	GK	450	500
			GL	500	550
			GM	550	600
40/50/57/6500K	70	72	GN	600	650
			GP	650	700
			GQ	700	750
	80	82	GN	600	650
			GP	650	700
			GQ	700	750
	90	92	GL	500	550
			GM	550	600
			GN	600	650

* Tolerance of measurements of the Luminous Flux is $\pm 7\%$.

* Ra measurement tolerance is ± 2 .

Forward Voltage Ranks, $I_F = 200\text{mA}$, $T_j = 25^\circ\text{C}$

Code	Min	Max	Unit
6D	22	24	V
6E	24	26	V
6F	26	28	V

* Tolerance of measurements of the Forward Voltage is $\pm 3\%$.

CIE Chromaticity Diagram, $I_F = 200\text{mA}$, $T_j = 25^\circ\text{C}$

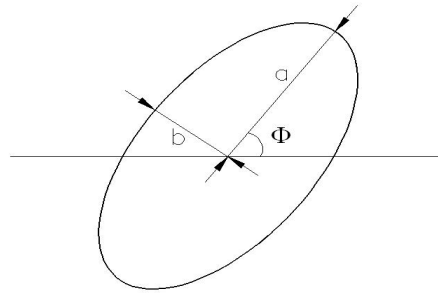

The color ranks have chromaticity ranges within 5-step MacAdam ellipse

Color Code	Center ($T_j = 25^\circ\text{C}$)		Center ($T_j = 85^\circ\text{C}$)		Radius		Angle(deg)
	x	y	x	y	a	b	Φ
27R5	0.4620	0.4145	0.4578	0.4101	0.013500	0.007000	53.42
30R5	0.4383	0.4081	0.4338	0.4030	0.013900	0.006800	53.13
40R5	0.3875	0.3868	0.3818	0.3797	0.015650	0.006700	53.43
50R5	0.3507	0.3635	0.3447	0.3553	0.013700	0.005900	59.37
57R5	0.3348	0.3491	0.3287	0.3417	0.011175	0.005500	58.35
65R5	0.3187	0.3363	0.3123	0.3282	0.011150	0.004750	58.34

* Energy Star binning applied to all 2600~7000K.

* Tolerance of measurements of the chromaticity Coordinate is ± 0.005 .

Fig 1. Color Spectrum, Tj = 25°C Ra≥70

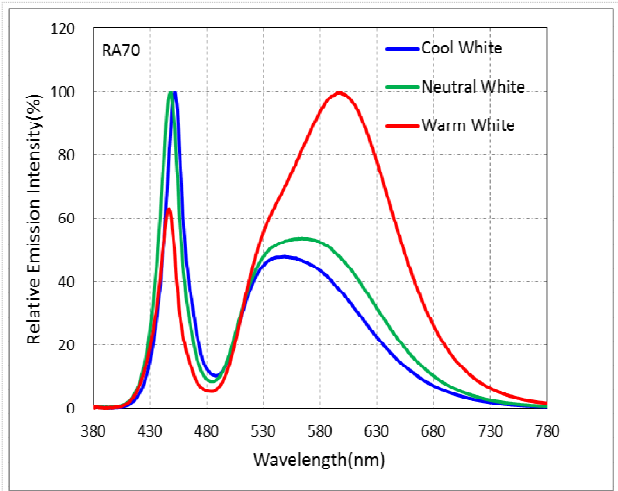

Fig 2. Color Spectrum, Tj = 25°C Ra≥80

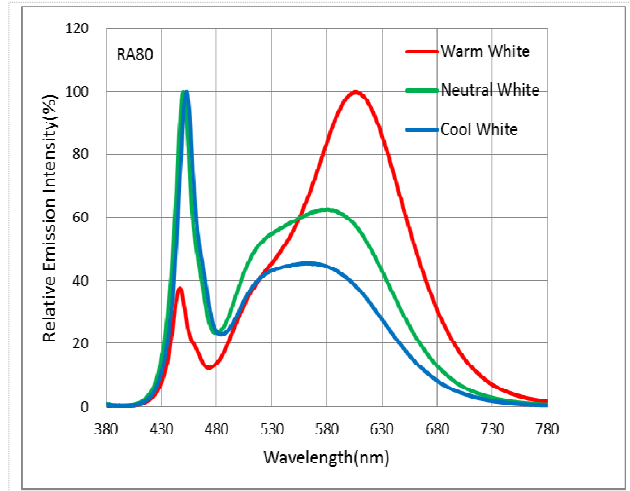

Fig 3. Color Spectrum, Tj = 25°C Ra≥90

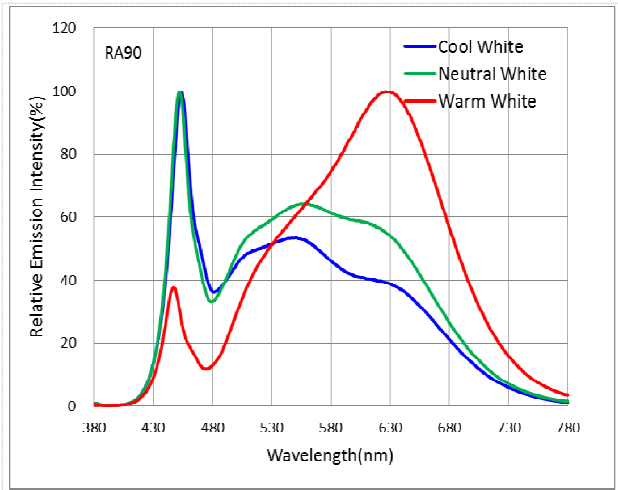
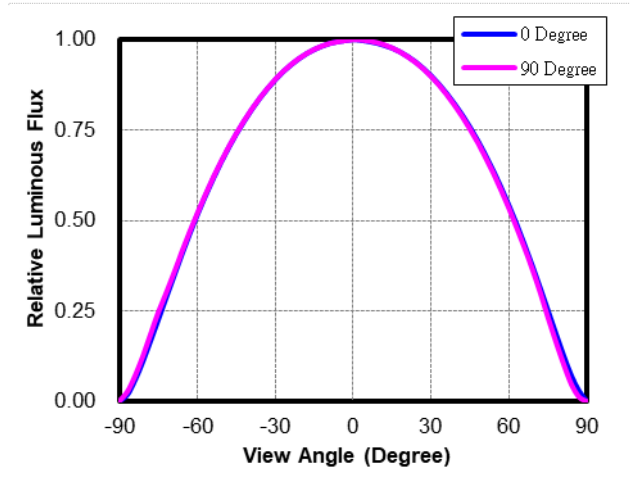
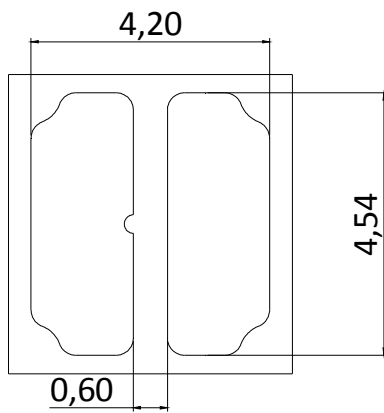
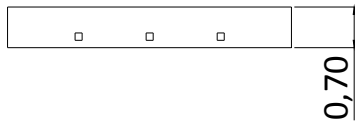
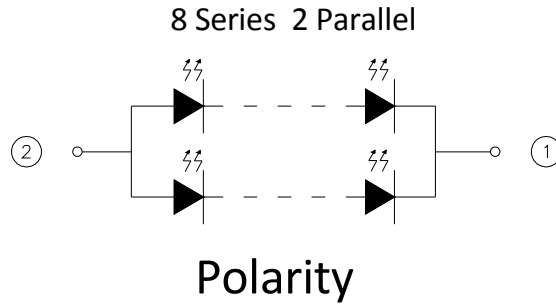
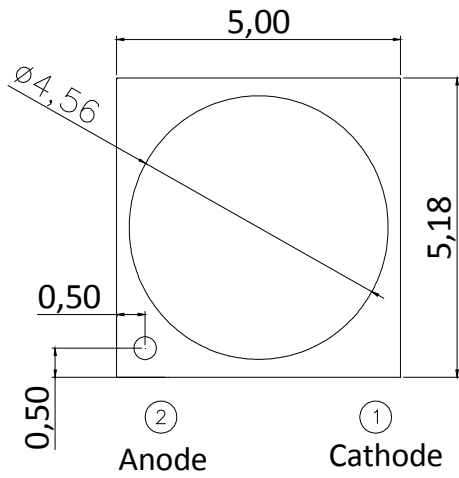

Fig 2. Viewing Angle Distribution, Tj = 25°C



Package Dimensions



Bot. view

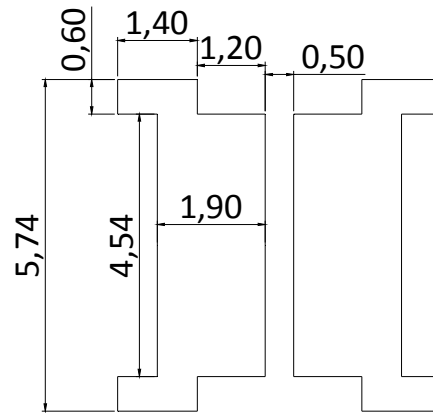

Soldering patterns

* The tolerance unless mentioned is $\pm 0.1\text{mm}$, unit = mm.

Reflow Soldering Characteristics

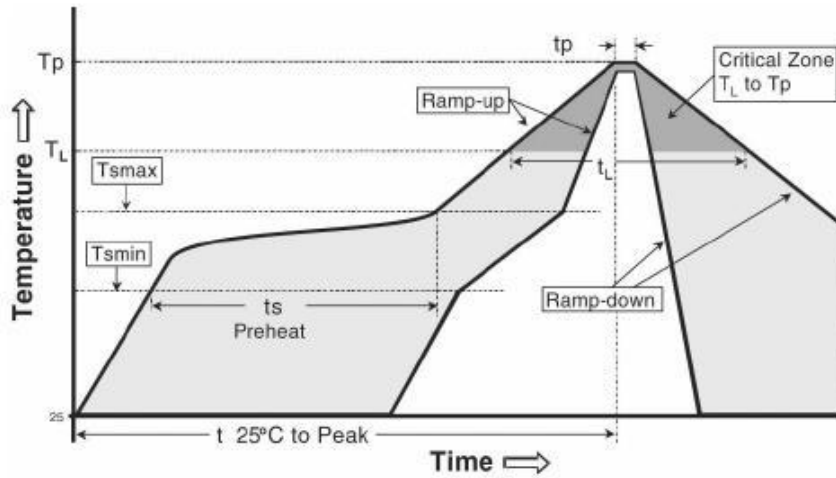

Reflow soldering	
Temperature Min (T Amin)	150° C
Temperature Max (Tsmax)	200° C
Time(ts)from (T Amin to Tsmax)	60-120 seconds.
Ramp-up rate (TL to Tp)	3° C/seconds max.
Liquidous temperature(TL)	217° C
Time(tL) maintained above TL	60-150 seconds
Peak package body temperature(Tp)	260° C max
Time (tp) within 5° C of the specified classification temperature (Tc).	30 seconds max
Ramp-down rate (Tp to TL)	6° C/second max
Time 25 ° C to peak temperature	8 min max

Package Dimensions of Tape

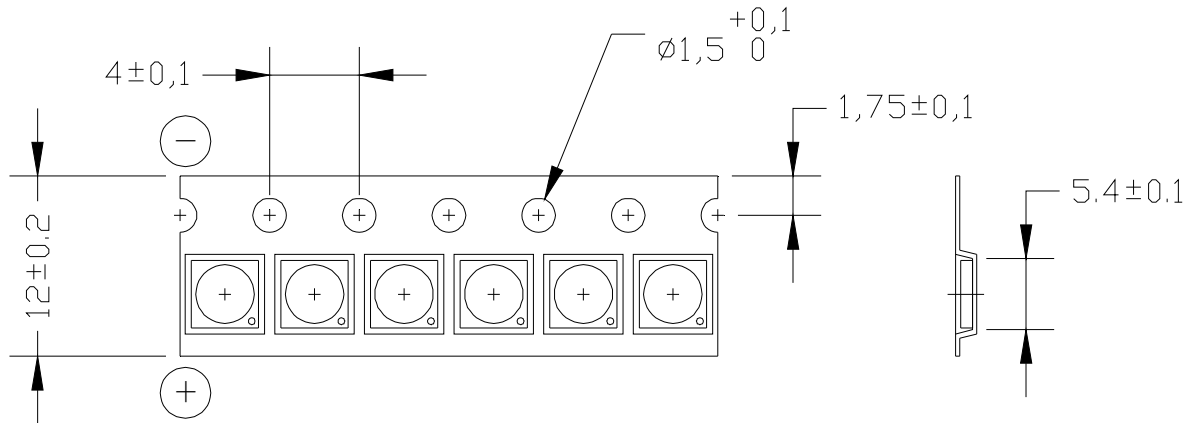

- * Quantity : Max 2000pcs/Reel
- * Cumulative Tolerance : Cumulative Tolerance/10 pitches to be $\pm 0.2\text{mm}$
- * Package : P/N, Manufacturing data Code No. and Quantity to be indicated on a damp proof Package.
- * Adhesion Strength of Cover Tape Adhesion strength to be 0.1-0.7N when the cover tape is turned off from the carrier tape at the angle of 10° to the carrier tape

Package Dimensions of Reel

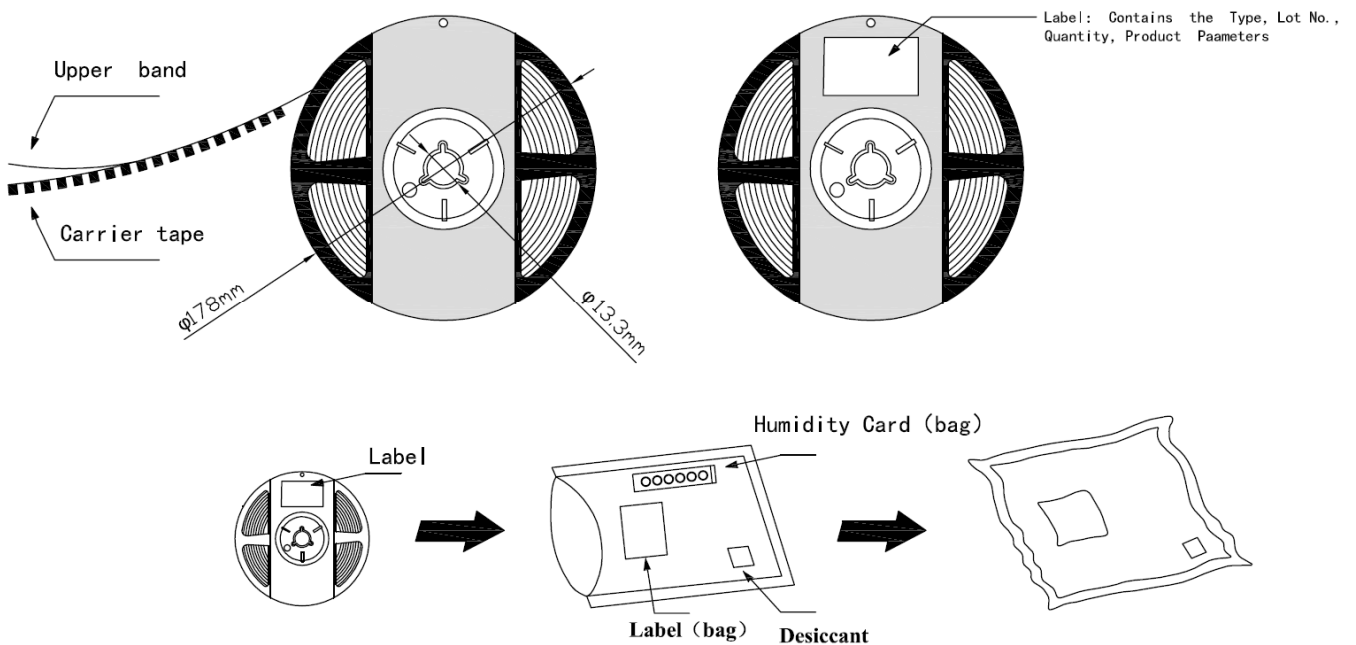

Package Box

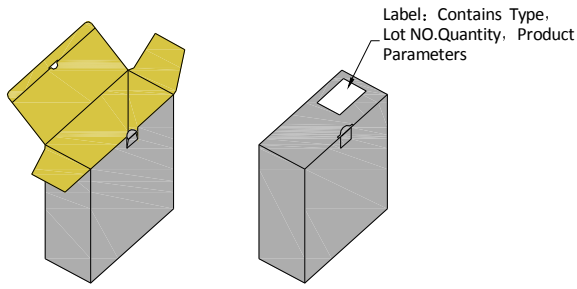

* Capacity 4 or 8 reels per box.

Outer Box

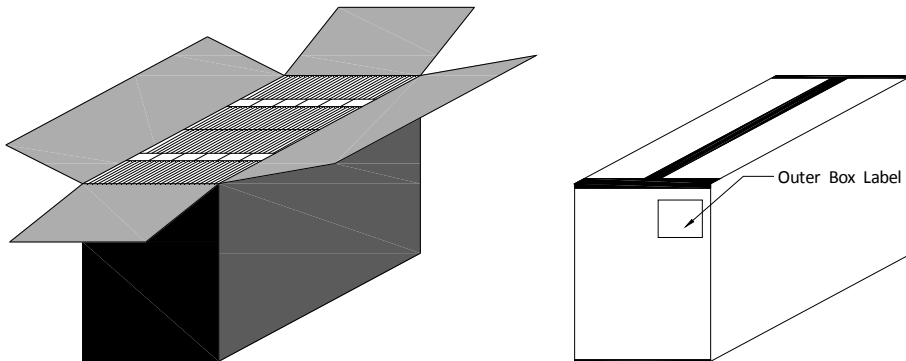

* Capacity 24 or 48 reels per box.

Label :

福建天电光电有限公司
FUJIAN LIGHTNING OPTOELECTRONIC CO.LTD

型号Type:T*****_*****



光通量 Φ @ *** mA: *** _ *** [LM]

色区Color Bin@*** mA: ****

电压Vf@ *** mA: ** - ** [V]

显指Ra@ *** mA: ** (MIN)

Lot No.:A*****_*_*****

Bin Code: **** 数量QTY:**** PCS



Caution

1. Reflow soldering is recommended not to be done more than two times. In the case of more than 24 hours passed soldering after first, LEDs will be damaged.
2. Repairs should not be done after the LEDs have been soldered. When repair is unavoidable, suitable tools must be used.
3. Die slug is to be soldered.
4. When soldering, do not put stress on the LEDs during heating.
5. After soldering, do not warp the circuit board.

Notes on Lightning EMC Series soldering:

1. Recommend to use reflow machine.
2. Recommend to use heating plate soldering.
3. Manual soldering is not recommended.

Notes on reflow process:

1. To confirm whether the actual temperature curve in the reflow soldering conditions comply with recommended conditions. LEDs are guaranteed for one time reflow.
2. During reflow process do not apply force on LED active area.
3. After reflow process, PCB board should be cooled down before packing or storage.

Precaution for use

Storage

1. Before opening the package: The LED should be kept at 30°C or less and 90%RH or less.
2. After opening the package: The LED's floor life is 168Hrs under 30°C or less and 60%RH or less. If unused LED remain, it should be stored in moisture proof packages JEDEC (MSL 3).
3. If the moisture absorbent material (silica gel) has faded away or the LEDs have exceeded the storage time, baking treatment should be performed using the following conditions:
Baking treatment: 60±5°C for 24 hours.